

©

**microSnap
Expander Rings**

**microFrame
Wafer Frames**

**microSnap
Storage**

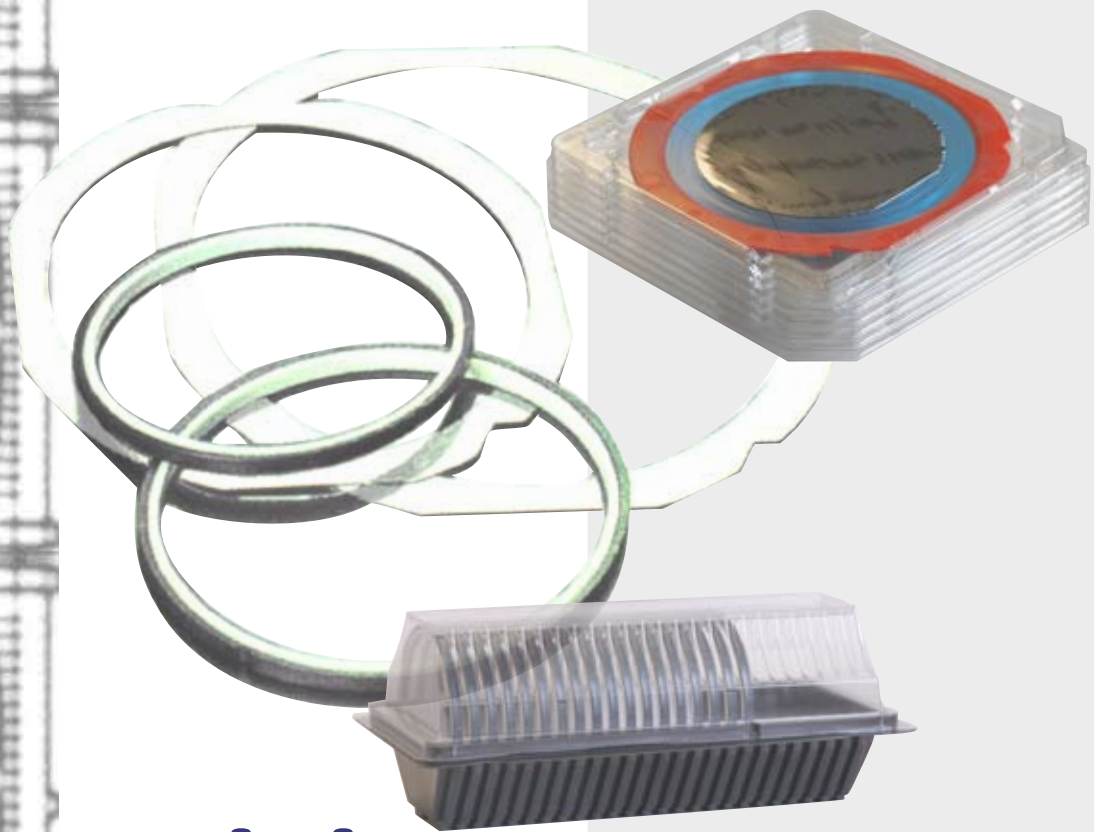

mitron
elektronik gmbh

Wafer Frames (Film Frames) and Expander Rings (Dicing Rings) are well approved devices in the automated processing of wafers and substrates in round and square shape. Both are used as the carrier of adhesive tape (Dicing Tape, Carrier Tape,

Expansion Tape) in the dicing process and during diebonding.

microSnap Expander Rings

These rings in sizes for 3" to 12" wafers are elastic to grip tapes of different thickness equally well. Fibre reinforced polycarbon ensures high stability of shape.

microSnap expander rings are ideal for use in magazines. With their height of 6mm and their low weight microSnap rings are a perfect shipping tray when directly stacked.

A high contrast in color - the outer ring is dark, the inner ring is bright eases handling. Mortise and tenon prevent the tensioned / expanded tape from slipping. Rounded edges warrant that the tape wont be cut.

For type ER145-4 (4" wafer) we also provide round, dusttight plastic enclosures, which enable secure storage and shipping of 5+1 or 10+1 rings.

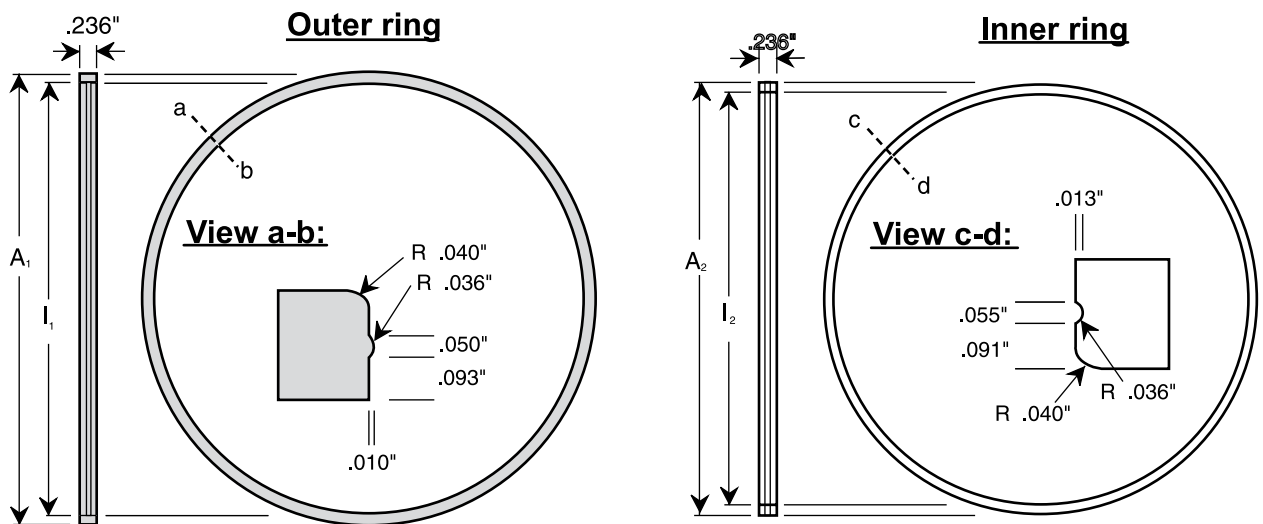

Figure 1

Type-number	Wafer-size	Outer ring (black)				Inner ring (white)			
		outside-Ø A ₁		Inside-Ø I ₁		Outside-Ø A ₂		Inside-Ø I ₂	
		[inch]	[mm]	[inch]	[mm]	[inch]	[mm]	[inch]	[mm]
ER121-3	3" (75 mm)	4.990	127	4.762	121	4.768	121	4.530	115
ER145-4	4" (100 mm)	5.981	152	5.744	146	5.750	146	5.520	140
ER177-5	5" (125 mm)	7.322	186	7.000	178	7.010	178	6.689	170
ER202-6	6" (150 mm)	8.280	210	7.975	203	7.973	203	7.670	195
ER237-8	8" (200 mm)	9.720	247	9.320	237	9.315	237	8.910	226
ER345-12	12" (300 mm)	14.09	358	13.58	345	13.58	345	13.15	334

Tab. 1

All dimension approximate, not for construction.
Subject to modifications

microFrame Wafer frames

Wafer frames for 3" to 12" wafers are established in three different shapes to match the handling and stacking systems from leading equipment manufactures.

We provide wafer frames for all major systems, but the K&S and DISCO types are the most commonly used.

microFrame wafer frames are made of hardened stainless steel (as an option nonmagnetic), of aluminum, PVC or acrylic.

The aluminum and plastic types are light-weighted and intended for use in transport. For lowcost oneway shipments, the acrylic and pvc types are best used.

For inhouse use stainless steel frames are state of the art. Their long lifetime, high planarity, and their electropolished, deburred surface stand for safe automated handling.

microMag magazines with plastic sides and anodized spacers are the most commonly used frame magazines for all major frame systems.

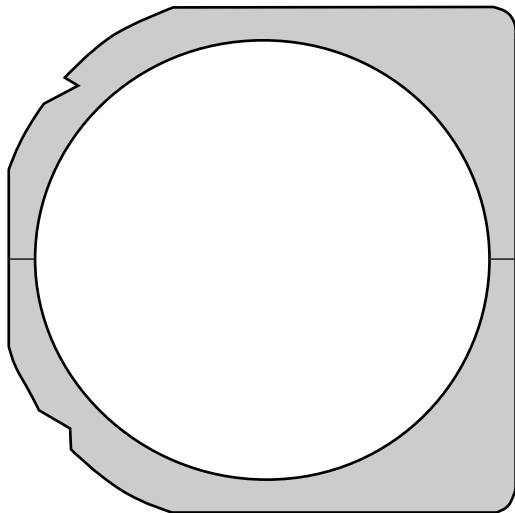

Figure. 2

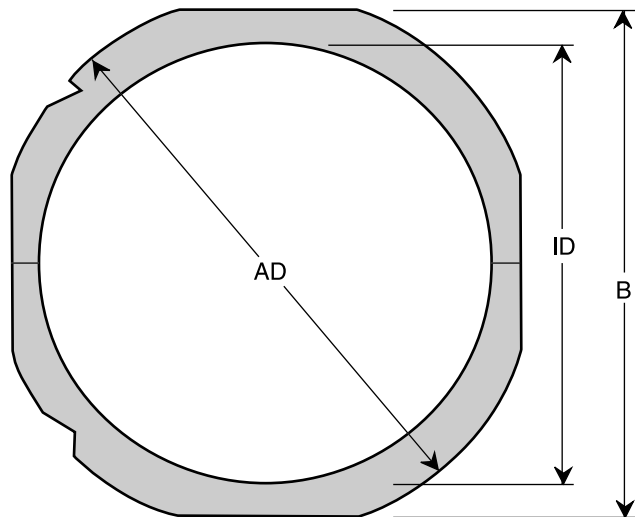

Figure. 3

Type-number	Wafer-size	Width B		Inner-Ø ID		Outer-Ø AD		Thickness	
		[inch]	[mm]	[inch]	[mm]	[inch]	[mm]	[inch]	[mm]
WF4-168-S5-xx	4" (100 mm)	6.82	168	5.85	149	quadr.		.030	0,76
WF5-184-S1-xx	5" (125 mm)	7.25	184	6.50	165	7.68	195	.048	1,22
WF6-212-S1-xx	6" (150 mm)	8.35	212	7.64	194	8.98	228	0.39/.048	1.00/1,22
WF6-212-P2-xx	6" (150 mm)	8.35	212	7.64	190	8.98	228	.079	2.00
WF6-216-P2-xx	6" (150 mm)	8.50	216	7.25	184	8.98	228	.090	2,30
WF6-216-S1-xx	6" (150 mm)	8.50	216	7.59	193	8.98	228	.048	1,22
WF8-267-Sx-xx	8" (200 mm)	10.50	267	9.55	243	11.08	281	.048/.059	1,22/1.55
WF8-276-Sx-xx	8" (200 mm)	10.87	276	9.84	250	11.61	295	.048/.059	1,22/1.55
WF8-276-P2-xx	8" (200 mm)	10.87	276	9.84	250	11.61	295	.106	2.70
WF12-380-S3-xx	12" (300 mm)	14.96	380	13.78	350	15.75	400	.059	1,55

X=Material (S=Stainless Steel, A=Aluminum, P=Plastic) xx= Rev. Nr

Tab. 2

All dimension approximate, not for construction.
Subject to modifications

Specializing and shifting of production processes require cost efficient and save solutions for storage and transport.

Reusable or one-way - our containers offer dust free and antistatic shelter for your components.

Clamping devices, guide rails or padding prevent rings or frames in the container from moving.

microSnap blister container



Two-piece container for storage or shipping of 25 pcs of wafers on expander rings

The rigid bottom is black, made from PS / el. conductive.

The light top is clear, made from PET / antistatic.

Partnumbering:

STB - X - 25 - xxx

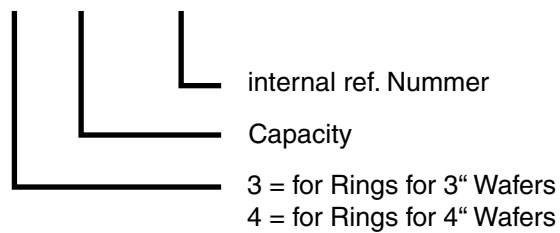

staCpac Tray



Storage or transport of single wafers on frames or expander rings. It consists of a single piece made from antistatic PET. An empty tray can be used as top.

The trays for 6" wafers on frames can alternatively be loaded with an expander ring for 3", 4" or 5" wafers. The trays for 8" wafers on frames can alternatively

Partnumbering:

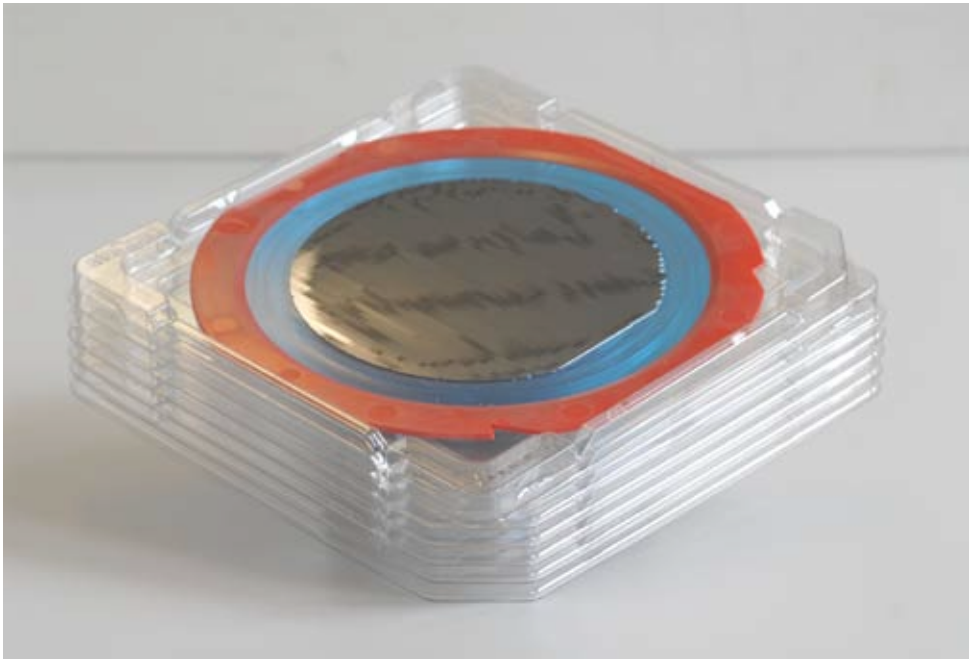
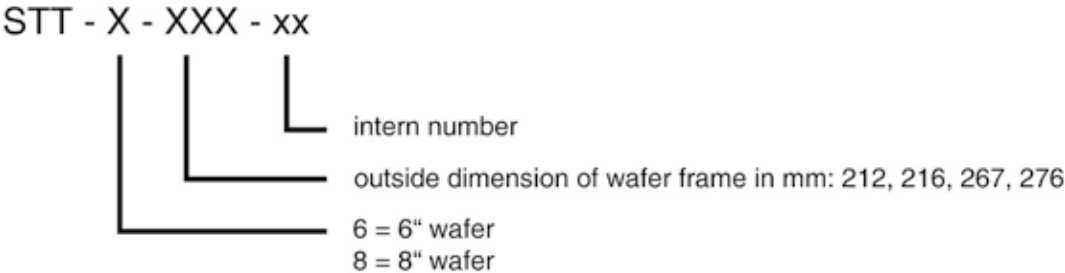

microsnap Container

Boxes made of PP for 5 or 10 wafers on grip rings, stacked.
Lining around inner wall and cushions as cover are available. Both made of black antistatic foam.

Partnumbering:

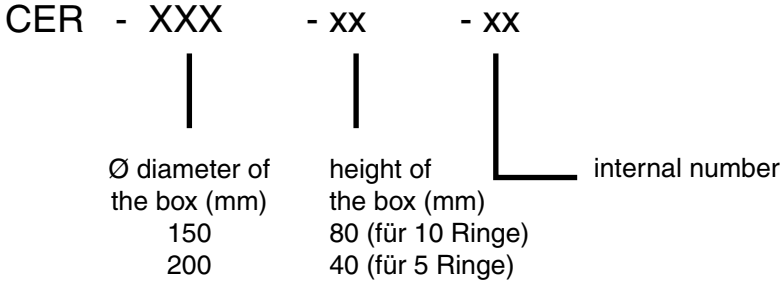

ULTRON SYSTEMS dicing tapes

The large program of dicing tapes by **ULTRON SYSTEMS** includes PS or UV-tapes using base films of PVC, PO or PET. The special **ULTRON SYSTEMS** technology is silicone - free for all types of film using a special surface treatment of the base tape. Several antistatic tapes are available, too. We also provide small quantities, everything with short delivery time.

Please ask us for our special catalogue for **ULTRON SYSTEMS** dicing tapes.



PS tape free of silicon release agents based on PO (stiff) or PVC (ductile).

Packaging solutions - We'll be happy to help.

Container for Wafer Frames horizontal



Container for Wafer Frames vertikal



“Pizza Boxen“für einzelne Wafer Frames/Ringe



Kassetten für Ringe

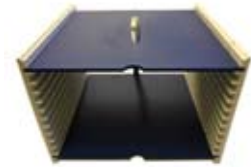

Membrane boxes for chips





minitron

elektronik gmbh

Noerdl. Ringstr. 14

D-85057 Ingolstadt

Tel. 0841 / 82077

Fax 0841 / 84404

<http://www.minitron.com>

eMail: info@minitron.com